



BURTON

DESIGN — TOAN NGUYEN

Il componibile Burton rappresenta un'innovazione progettuale del sistema divano, in cui struttura e proporzioni definiscono una nuova architettura dell'imbottito. Burton si compone attraverso un processo di aggregazione unico nel suo genere, con una piattaforma in tre diverse profondità (Burton S 96 cm / Burton M 108 cm / Burton XL 120 cm) più elementi singoli, due diverse altezze schienale (67 - 72 cm) e due diverse altezze di bracciolo (59 - 67 cm), declinabile in conformazioni molto diverse tra loro, permettendo un'ampia personalizzazione del sistema divano. Il prodotto è altresì personalizzabile attraverso differenti cuscinate e sofisticati motivi estetici, 4 tipologie di cuciture per tessuto e 5 per la pelle, che evidenziano fortemente il prodotto lungo il suo sinuoso profilo.

Tecnologia Busnelli_Lab

The modular sofa Burton represents a projecting innovation in the sofa system, where structure and proportions define a new architecture of the product. Burton is made through a process of aggregation with a unique platform in three different depths (Burton S 96 cm / Burton M 108 cm / Burton XL 120 cm), several individual elements, two different backrest heights (67 - 72 cm) and two different armrest heights (59 - 67 cm), all declinable in conformations very different from each other, allowing extensive customization of the sofa system. The product is also customizable with different cushions and also thanks to sophisticated aesthetic finishes such as four different stitchings on fabric and five on leather that strongly underline the product along its sinuous profile.

Technology by Busnelli_Lab

BURTON M TOAN NGUYEN

STRUTTURA —

La struttura portante è in massello, multistrati e agglomerato di legno. Il molleggio di seduta è disposto da cinghie elastiche.

IMBOTTITURA —

L'imbottitura è in poliuretano espanso indeformabile a densità differenziate senza C.F.C., rivestita con falda di fibra 100% poliestere.

Il sedile ha il cuscino in piuma d'oca, selezionata e sterilizzata, con anima portante in poliuretano espanso indeformabile a densità differenziate senza C.F.C.

BASAMENTO —

Piedino a slitta in trafilato d'acciaio.

DETTAGLI —

Disponibili elementi componibili predisposti per il collegamento. Completamente sfoderabile, esclusa la versione in pelle.

STRUCTURE —

The structure is made of solid wood, plywood and particle board. The springing of the seat is made of elastic belts.

PADDING —

The padding is in polyurethane foam in different densities C.F.C.-free, coated with a layer of 100% polyester fiber.

The seat cushion is filled with selected and sterilized goose down with supporting heart in polyurethane foam in different densities C.F.C.-free.

BASE —

Feet in drawn steel.

DETAILS —

Available modular units ready for connection. Removable covers except for the leather version.

BURTON M TOAN NGUYEN

Divano / Sofa

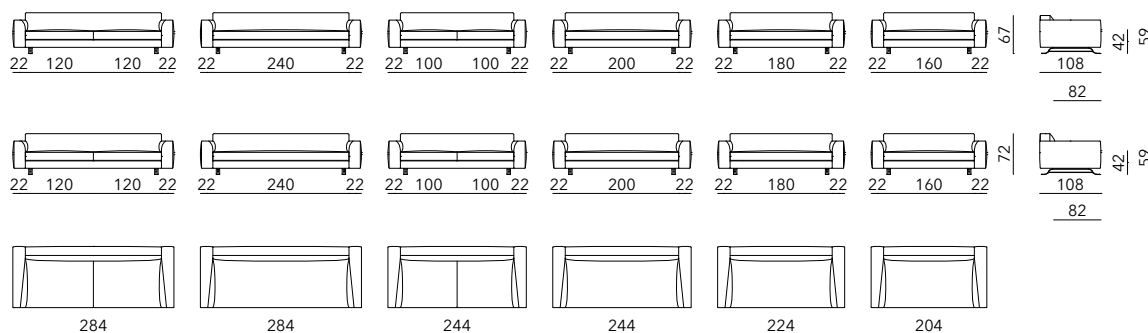

Terminale con bracciolo S.G. o D.G. / End unit with armrest L.F. or R.F.

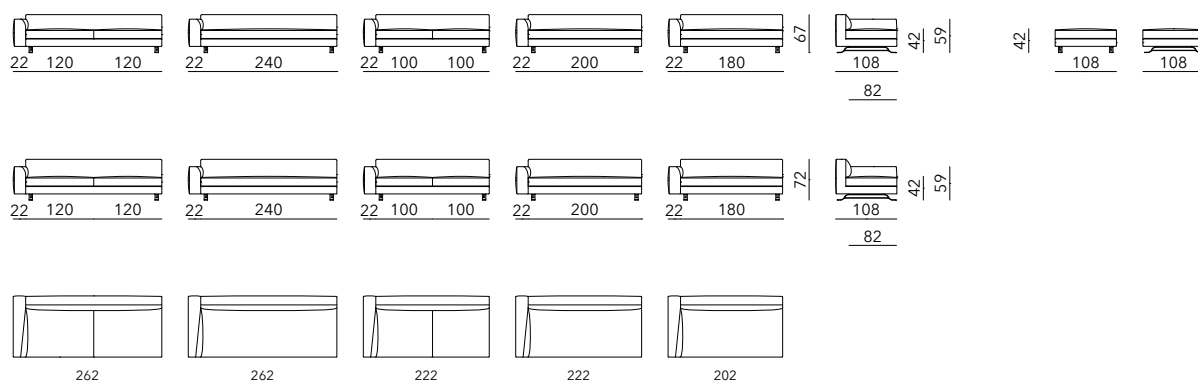

BURTON M TOAN NGUYEN

Dormeuse con bracciolo S.G. o D.G. /
Long chair with armrest L.F. or R.F.

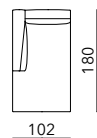
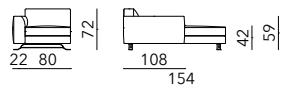
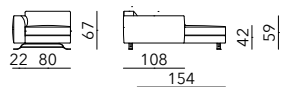

Angolare con allungo S.G. o D.G. /
Corner unit with longside L.F. or R.F.

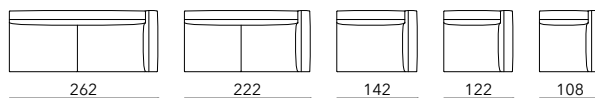
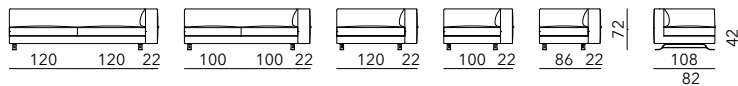
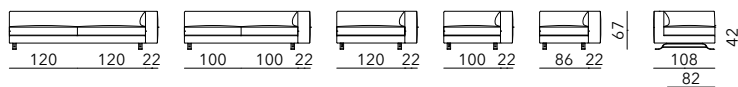

Elemento centrale / Central unit

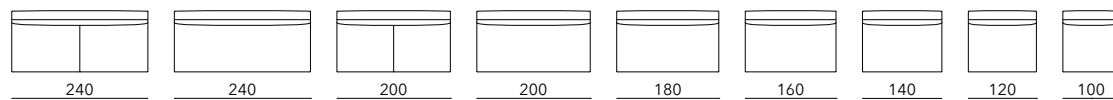
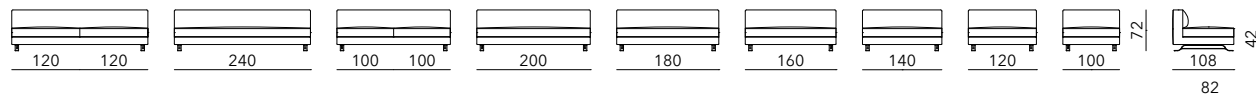
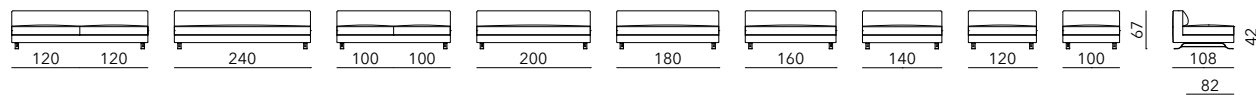

Angolare con bracciolo S.G. o D.G. / Corner unit with armrest L.F. or R.F.

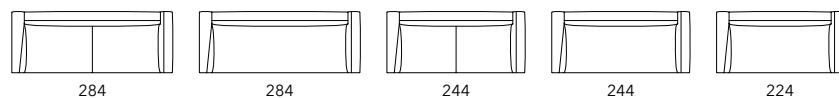
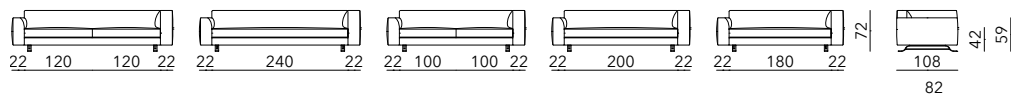
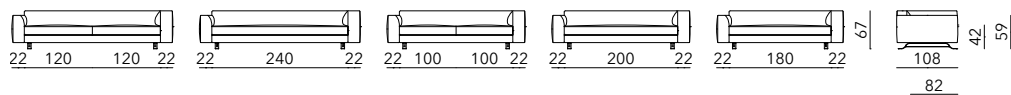

BURTON S TOAN NGUYEN

Divano / Sofa

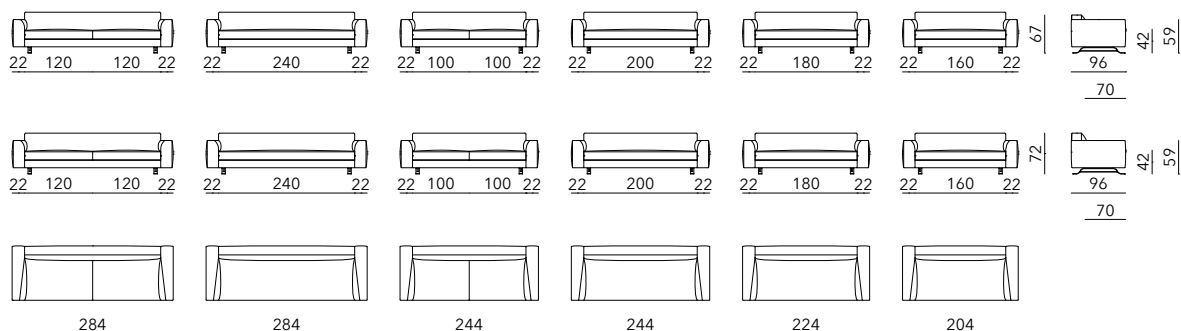

Pouf / Footstool

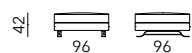

BURTON / XL

TOAN NGUYEN

Divano / Sofa

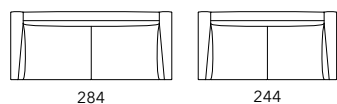
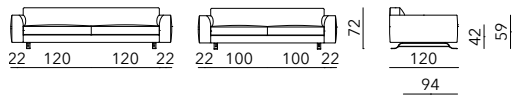
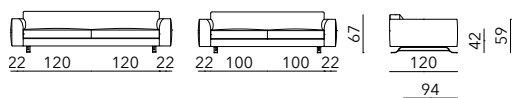

Terminale con bracciolo S.G. o D.G. / End unit with armrest L.F. or R.F.

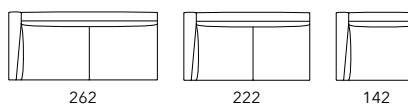
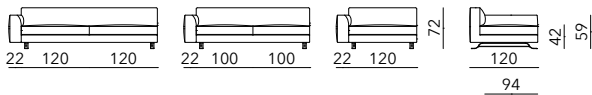
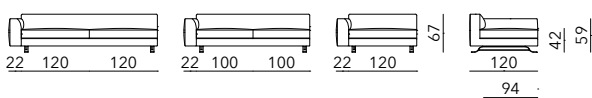

Dormeuse con bracciolo S.G. o D.G. / Long chair with armrest L.F. or R.F.



Angolare con allungo S.G. o D.G. / Corner unit with longside L.F. or R.F.

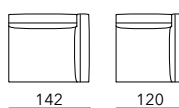
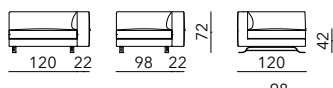
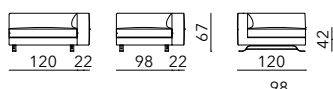

Elemento centrale / Central unit

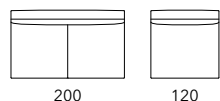
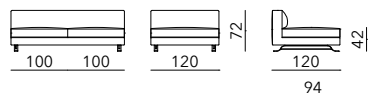
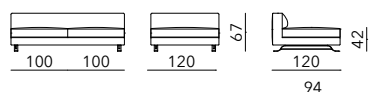

Pouf / Footstool

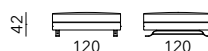

BURTON M / S / XL ESEMPI DI COMPOSIZIONI / COMPOSITION EXAMPLES TOAN NGUYEN

BURTON M profondità 108 cm / depth 108 cm

BURTON M profondità 108 cm / depth 108 cm



BURTON M / S / XL ESEMPI DI COMPOSIZIONI / COMPOSITION EXAMPLES TOAN NGUYEN

BURTON S profondità 96 cm / depth 96 cm

BURTON XL profondità 120 cm / depth 120 cm

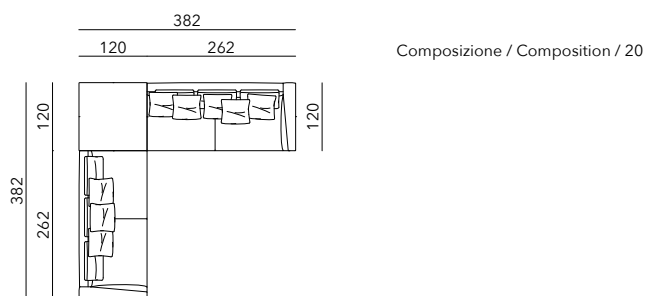
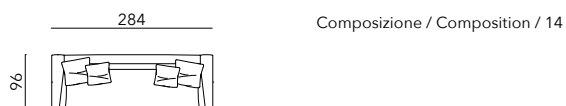
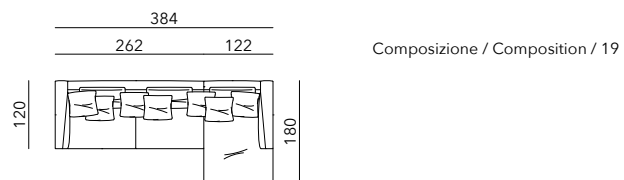

BURTON profondità miste / mixed depths

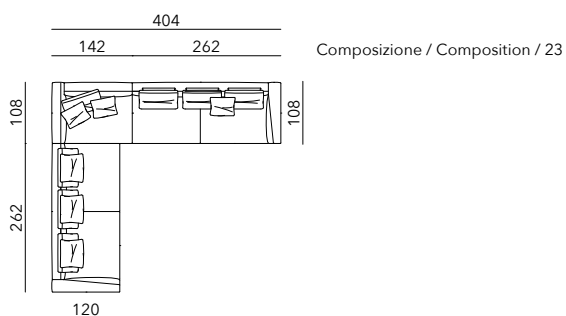
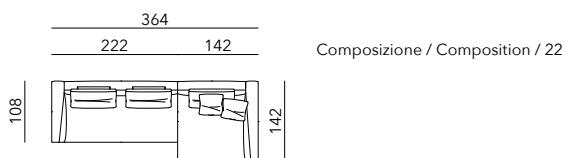

BURTON M / S / XL VARIANTI / VARIANTS TOAN NGUYEN

Varianti profondità / Variants depth

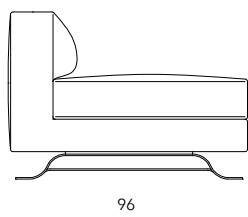

96

BURTON S

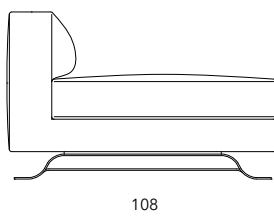

108

BURTON M

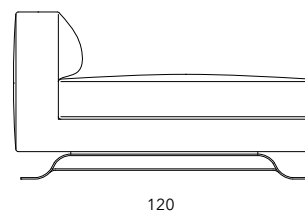

120

BURTON XL

Varianti altezza schienale / Variants backrest height

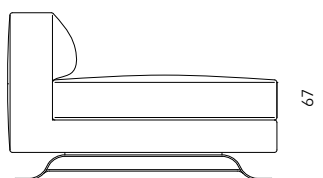

67

Schienale low /
Backrest low

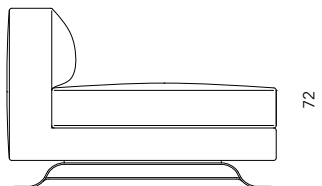

72

Schienale medium /
Backrest medium

Varianti altezza bracciolo / Variants height armrest

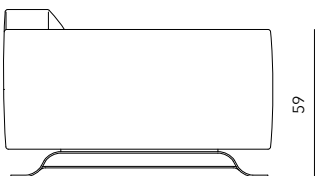

59

Bracciolo basso /
Armrest low

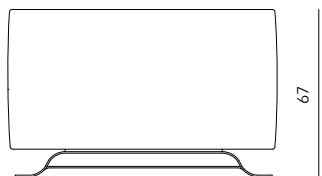

67

Bracciolo alto /
Armrest high

BURTON M / S / XL CUSCINI / CUSHIONS TOAN NGUYEN

Varianti cuciture tessuto/ Options fabric seams

- Cod.A Costina semplice /
Simple stitching

- Cod.E Con punto cavallo /
Blanket stitching

- Cod. N Profilo con cordonetto in tessuto /
Profile with string and fabric piping

- Cod. P Profilo con cordonetto in gros grain /
Sewing with string and gros grain

Varianti cuciture pelle/ Options leather seams

- Cod.A Costina semplice cucitura in tinta /
Simple stitching same color

- Cod.F Costina semplice cucitura in contrasto /
Simple stitching in contrast color

- Cod.H Fettuccia e doppia costina /
Double stitching

- Cod.N Profilo con cordonetto in pelle /
Profile with string and leather piping

- Cod.P Profilo con cordonetto in gros grain /
Sewing with string and gros grain

Cuscini schienale / Backrest cushions

L.60 P.12 H.55

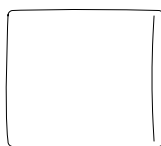

L.68 P.12 H.55

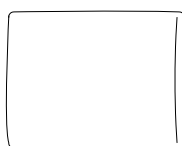

L.80 P.12 H.55

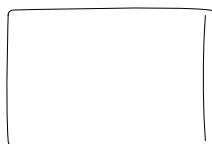

L.90 P.12 H.55



Cuscini optional / Optional cushions

L.45 x H.45

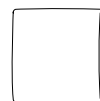

Cod. S40
L.40 x H.40



Cod. S50
L.50 x H.50

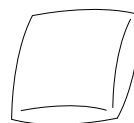

Cod. S60
L.60 x H.60

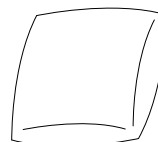

Cod. 60x60 light
L.60 x H.60

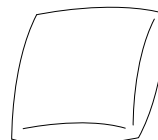

Rullo opzionale / Optional roll

Cod. R58
L.58 H.10

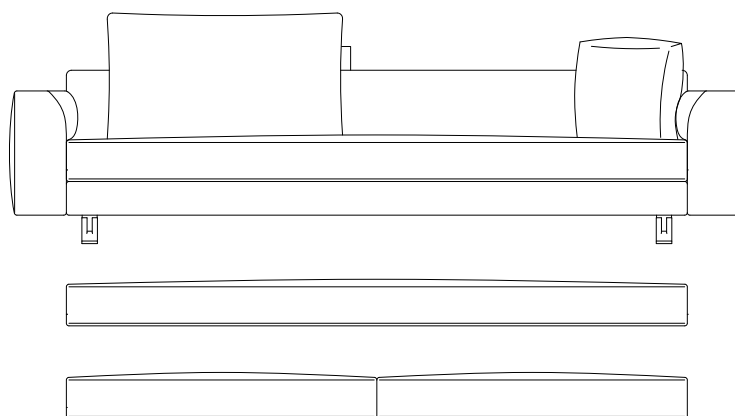
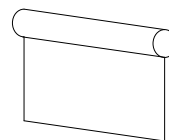

Nelle larghezze di seduta 240 e 200 disponibile con 1 o 2 cuscini sedile
In seat width 240 and 200 available with 1 or 2 seat cushions

BURTON
TOAN NGUYEN

FINITURE/ FINISHES

PIEDI/ FEET



CROMO NERO/
BLACK CHROME

CUCITURE TESSUTO/ FABRIC SEAMS

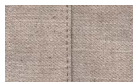

A- COSTINA SEMPLICE/
SIMPLE STITCHING



E- CUCITURA CON
PUNTO CAVALLO/
SEAM WITH BLANKET
STITCHING

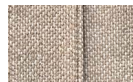

N- PROFILO CON
CORDONE IN TESSUTO/
PROFILE WITH STRING
AND FABRIC PIPING



P- PROFILO CON CORDONETTO
IN GROS GRAIN/
SEAM WITH STRING IN
GROS GRAIN

CUCITURE PELLE/ LEATHER SEAMS



A- COSTINA SEMPLICE
CON CUCITURA IN TINTA/
SIMPLE STITCHING WITH
SAME COLOUR SEAM

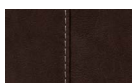

F- COSTINA SEMPLICE
CON CUCITURA
IN CONTRASTO/
SIMPLE STITCHING WITH
CONTRAST COLOR
SEAM



H- CUCITURA CON
FETTUCIA E DOPPIA
COSTINA/
SEAM WITH TAPE AND
DOUBLE STITCHING



N- PROFILO CON
CORDONETTO IN
PELLE/
PROFILE WITH STRING
IN LEATHER



P- PROFILO CON
CORDONETTO IN
GROS GRAIN/
SEAM WITH STRING IN
GROS GRAIN